

Ceiling mounts

for flat panels

Not only the flat panel itself is an important element in a professional installation.

Installation speed, adjustability and stability of the accessories are important features.

Audipack introduces the new generation ceiling mounts for flat panels.



Audipack[®]

It's great to have solutions...

Stylish and

Professional!

Audipack's flat panel ceiling mounts are durable mounting solutions, with the advantages of height and angle adjustment of the flat panel.

The NEW flat panel ceiling mounts are slim and minimalistic designed ceiling mounts suitable for any brand and type. This product line allows quick installation, and a visual complementing installation. Continuous screen adjustment and neatly hidden cables through the tubes are standard features.

Fixed lengths and telescopic versions are available to position the screen perfectly on every height and location.

- *The CMV1 and CMV2 series* offers the advantages of a new special ball-joint, the screen is easy to aim and adjust towards the viewer. This product line offers the standard VESA 75, 100 and 200 mounting patterns.
- *The FCM and FCMD series* are a durable and rigid product line that offers flexibility in using the larger single or back to back installed screens. Perfect for pro AV installation projects.

With the standard available options it is very easy to adapt the ceiling mounts that meets your installation specifications.

The 700 series flat panel ceiling mounts are designed for installations with large screens installed at longer distances from the ceiling. The product stability allows a slim but long ceiling mount, hiding all needed cables and offering a continuously height adjustable mounting head with forward inclination.

With the Audipack Lock&Secure system the flat panel is easy mounted and quickly secured. Custom-made models are available in several lengths up to 4 meter.

- ▲ *Telescopic models available*
- ▲ *Perfectly angle adjustment*
- ▲ *VESA and L&S 5 suited*
- ▲ *All cables hide through the tube*



Angle adjustment



Neatly installed cables



















20° adjustment and standard lockable



Standard ceiling finishing on all models









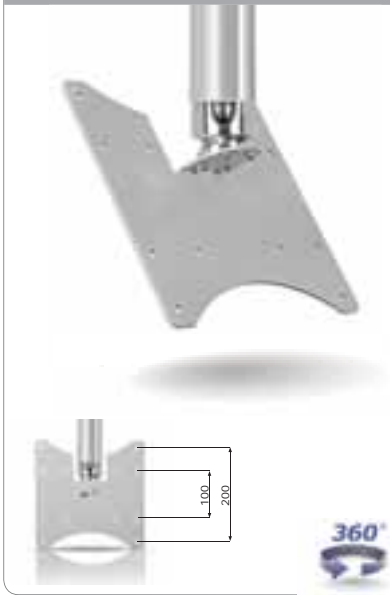



CMV1 SERIES: CEILING MOUNTS WITH VESA 75 & 100



Ref.	CMV1-0300				
Length in mm	300				
Tube diameter in mm	54				
Tilt adjustment in degrees	0-27°				
Ref.	CMV1-0500				
Length in mm	500				
Tube diameter in mm	54				
Tilt adjustment in degrees	0-27°				
Ref.	CMV1-0800				
Length in mm	800				
Tube diameter in mm	54				
Tilt adjustment in degrees	0-27°				
Ref.	CMV1-1000T				
Length in mm	604-1000 (Telescopic)				
Tube diameter in mm	54-60				
Tilt adjustment in degrees	0-27°				

CMV2 SERIES: CEILING MOUNTS WITH VESA 100 & 200















Ref.	CMV2-0500				
Length in mm	500				
Tube diameter in mm	54				
Tilt adjustment in degrees	0-27°				
Ref.	CMV2-0800				
Length in mm	800				
Tube diameter in mm	54				
Tilt adjustment in degrees	0-27°				
Ref.	CMV2-1500T				
Length in mm	907-1500 (Telescopic)				
Tube diameter in mm	54-60				
Tilt adjustment in degrees	0-27°				

CMV4 SERIES: CEILING MOUNTS WITH VESA 200 & 400

NEW



Ref.	CMV4-0500				
Length in mm	500				
Tube diameter in mm	54				
Tilt adjustment in degrees	0-27°				
Ref.	CMV4-0800				
Length in mm	800				
Tube diameter in mm	54				
Tilt adjustment in degrees	0-27°				
Ref.	CMV4-1500T				
Length in mm	907-1500 (Telescopic)				
Tube diameter in mm	54-60				
Tilt adjustment in degrees	0-27°				

CEILING MOUNTS

FCM SERIES: CEILING MOUNTS WITH L&S 5



5 point mounting system
Bracket is required for screen mounting (page 29)

**Ref. FCM-1000**

Length in mm	1000
Tube diameter in mm	54
Tilt adjustment in degrees	0-20°

**Ref. FCM-1500**

Length in mm	1500
Tube diameter in mm	54
Tilt adjustment in degrees	0-20°

**Ref. FCM-1500T**

Length in mm	909-1500 (Telescopic)
Tube diameter in mm	54-60
Tilt adjustment in degrees	0-20°



FCMD SERIES: BACK TO BACK SOLUTIONS



5 point mounting system
Bracket is required for screen mounting (page 29)

**Ref. FCMD-1000**

Length in mm	1000
Tube diameter in mm	54
Tilt adjustment in degrees	0-20°

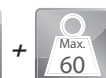
**Ref. FCMD-1500**

Length in mm	1500
Tube diameter in mm	54
Tilt adjustment in degrees	0-20°

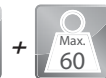
**Ref. FCMD-1500T**

Length in mm	909-1500 (Telescopic)
Tube diameter in mm	54-60
Tilt adjustment in degrees	0-20°

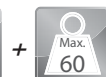

700 SERIES HEAVY DUTY COLUMN CEILING MOUNTS

**Ref. 390755**

Length in mm	available in lengths up to 4000 mm
Tilt adjustment in degrees	0-20° in 5° steps
Optional lock	Numeric: 230052 / Key: 230045
Optional ceiling finishing ring	CFR-700



5 point mounting system
Bracket is required for screen mounting (page 29)

Ref. 390758

Length in mm	available in lengths up to 4000 mm
Tilt adjustment in degrees	0-20° in 5° steps
Optional lock	Numeric: 230052 / Key: 230045
Optional ceiling finishing ring	CFR-700



5 point mounting system
Bracket is required for screen mounting (page 29)

XL CEILING MOUNT



Ref.	FCM-V600
Length in mm	1500 (other lengths available on request)
Tilt adjustment in degrees	15
Dimensions in mm	W 1300 x D 400 x H 1825
Mounting interface	VESA 400x200, 400x400, 600x200 and 600x400

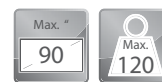

Ceiling mounts **ACCESSORIES**

MOUNTING BRACKETS FOR FLAT PANELS (SEE PAGE 29 FOR THE FULL PROGRAM)

See "Mounting brackets for flat panels" for the full program see page 29



Mount any brand and type of flat panel on any Audipack system with the Audipack mounting brackets.



Universal mounts



Brand related mounts



VESA mounts

EQUIPMENT CABINET



Ref.
Max. equipment dimensions in mm



EC-5
W 350 x D 350 x H 100

Suitable for the CMV-1 series
Suitable for power adapters etc.



ECV-1
W 218 x D 64 x H 78



EC-6
W 19" x 1HE/U

NEW



CAMERA SUPPORT



Ref.



CS-1



CEILING MOUNTS

VESA EXTENSION (ONLY SUITABLE ON CMV2)



 Max.
30

Ref. CMV-EX400 (VESA 300 x 300, 400 x 300, 400 x 400)

EXTENSION TUBES

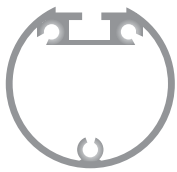

Diameter 54 mm.

 Ref.
Length in mm

 ET-1000
1000

 ET-1500
1500

 ET-2000
2000

 ET-2500
2500

MOUNTING HEAD (ONLY SUITABLE ON FCM AND FCMD)



 Max.
60

Ref.

FPH

FPHD

TRUSS MOUNTS (Ø 50 MM TRUSS)

 Ref.
Suitable for

 TM-54
54 mm tubes

 TM-60 (Telescopic tube sets only)
60 mm tubes

CEILING MOUNT PLATES WITH TILT ADJUSTMENT

NEWAdjustment: -5° to $+90^{\circ}$ 

Standard on:

 CMV1-1000T
 CMV2-1500T
 FCM-1000
 FCM-1500
 FCM-1500T
 FCMD-1000
 FCMD-1500
 FCMD-1500T

 Ref.
Suitable for

 CMP-4
60 mm tubes

 CMP-5
54 mm tubes